



## Safety Controller

# GC Series Main controller GC-1000/GC-1000R

### Instruction manual

Read this manual before using the product in order to achieve maximum performance. Keep this manual in a safe place after reading it so that it can be used at any time. This manual is the original instruction manual.

## Symbols

The following symbols alert you to important messages. Be sure to read these messages carefully.

	Indicates a hazardous situation which, if not avoided, will result in death or serious injury.
	Indicates a hazardous situation which, if not avoided, could result in death or serious injury.
	Indicates a situation which, if not avoided, could result in product damage as well as property damage.
	Indicates cautions and limitations that must be followed during operation.
	Indicates additional information on proper operation.

## Safety Precautions

### General precautions

	<ul style="list-style-type: none"> <li>This product is not intended for use as an explosion-proof device. Do not use this product in a hazardous location and/or potentially explosive atmosphere.</li> <li>KEYENCE does not guarantee the function or performance of this product if it is used in a manner that differs from the specifications contained in this manual or if this product is modified by the customer.</li> <li>Do not use the GC Series to control (stop forward motion, etc.) trains, cars and other transportation vehicles, aircraft, equipment for use in space, medical devices, or nuclear power generation systems.</li> </ul>
	<ul style="list-style-type: none"> <li>A failure in the output circuit or internal circuit may prevent the normal control operation. Be sure to install additional safeguards on any controls or systems that may result in serious accidents or fires.</li> <li>This product may become very hot while an electric current is applied and may still be hot immediately after stopping the unit. Do not touch it.</li> <li>When using network communication with the GC series, use it in an environment that is secure against network threats.</li> </ul>
	<ul style="list-style-type: none"> <li>When you dispose of the GC Series, always follow the applicable requirements of the laws, rules, regulations, and standards for disposing of industrial waste in the country or region where the GC Series is used.</li> </ul>
	<ul style="list-style-type: none"> <li>When this product is used in combination with other instruments, functions and performance may be degraded, depending on the operating conditions and surrounding environment.</li> </ul>

### Person responsible for safety management

	<ul style="list-style-type: none"> <li>The person responsible for safety management must train the assigned personnel for the correct use, installation, maintenance, and operation of the safety control system and the GC Series.</li> <li>The person responsible for safety management must have a sufficient understanding of the target utility, safety device, related laws and regulations, and safety standards. He/She must also have the necessary qualifications, authority, and responsibility to ensure safety in each stage: design, installation, operation, maintenance and disposal of the machine.</li> <li>Depending on the type of machine on which the GC Series is installed, there may be special safety regulations related to the use, installation, maintenance, and operation. In such a case, you must fulfill such safety regulations. The person responsible for safety management must introduce the GC Series in strict compliance with such safety regulations.</li> <li>The person responsible for safety management must check that the risks have been reduced sufficiently following the steps below, in accordance with the ISO13849-1/-2 requirements. The person responsible for safety management is responsible for checking/ approving that risks have been reduced sufficiently. <ul style="list-style-type: none"> <li>Perform a risk assessment.</li> <li>Define the safety functions executed by the control system and the safety levels to achieve when implementing protective measures as a result of the risk assessment.</li> <li>Check that a program created by the GC Configurator satisfies all of the safety functions and safety levels.</li> <li>Check that the implementation of the protective measures does not generate new hazards.</li> <li>Check that all of the risks have been reduced appropriately. If there are some risks which have not been reduced sufficiently, repeat the above steps until all of the risks are reduced appropriately.</li> </ul> </li> <li>The person responsible for safety management must approve and confirm that a program created by the GC Configurator matches the program displayed on the approval screen when transferring the program to the GC Series.</li> <li>The person responsible for safety management must perform a safety confirmation test (user test) before operating the system and check that all of the GC Series configuration data and the operations are correct.</li> <li>The user of the machine must receive specialized training related to the GC Series, and must then understand and adhere to the safety restrictions, laws, and regulations in the country or area where the GC Series is used.</li> <li>The user must verify that the GC Series is operating correctly in terms of functionality and performance before the start of the machine and the operation of the GC Series. If any abnormality is detected in startup, while starting the operation, or while running the machine, the user must stop the machine immediately and report the situation to the person responsible for safety management.</li> </ul>
--	--

### Connection device and wiring

	<ul style="list-style-type: none"> <li>Connect the appropriate input and control devices in order to achieve the required safety functions as determined by the risk assessment. When using an external device that has not met the appropriate safety level, the system will not meet the required safety level as determined by the risk assessment.</li> <li>Select an appropriate input and output device and set it with the GC Configurator according to the required safety specifications and safety level. The achieved safety level varies with the settings of the device.</li> <li>The GC Series assumes that all of the safety inputs are OFF when an internal error occurs. Therefore, only the input devices such as a safety light curtain, which forces the output OFF when an operator enters a hazardous area, and an emergency stop switch, which turns OFF in an emergency situation and forces the output OFF in a safe state, can be connected.</li> <li>The GC Series forces the safety output OFF when an internal error occurs. Therefore, only the control devices which eliminate a hazardous situation when the input turns OFF can be connected to the safety output.</li> <li>Use certified products for the devices/parts related to the safety functions which conform to the safety standards, etc. applicable to the purpose of use, in accordance with the safety restrictions, laws, and regulations in the country or area where the GC Series is used.</li> <li>Connect a dry contact or PNP output device to the GC Series. A NPN output device cannot be connected.</li> <li>If a safety level of SIL2, PLd or higher needs to be achieved when connecting a PNP output device, use a device that provides the inter-system short-circuit detection function of two OSSD outputs on the PNP output device side, such as Type 3 safety laser scanner and Type 4 safety light curtain.</li> <li>The safety output has a built-in diode to protect from surges caused by inductive loads. When using a surge absorber separately, connect it in parallel with the load. Note that a capacitive surge absorber with a built-in capacitor may cause a malfunction. It must be used within the range of specification.</li> <li>The safety output uses a PNP output. Therefore, be sure to connect a load between the safety output and 0 V. If the load is incorrectly connected between the safety output and +24 V, the safety output operation will be reversed, meaning the output will switch to the ON-state when it should be OFF, causing a very dangerous situation.</li> <li>To achieve a safety level of SIL3, PLe with a single safety output, apply protection to avoid short circuit between the safety output of the GC series and the power line, according to ISO 13849-2.</li> <li>To prevent malfunctions caused by ground faults, perform wiring in a manner such that the requirements specified in IEC 60204-1 are met.</li> </ul>
--	--

## ■ Safety control

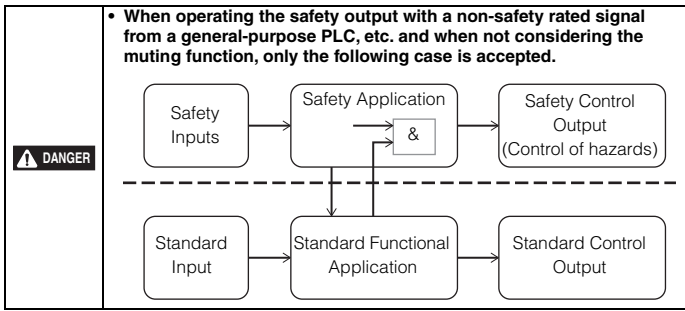

## ■ Safety precautions

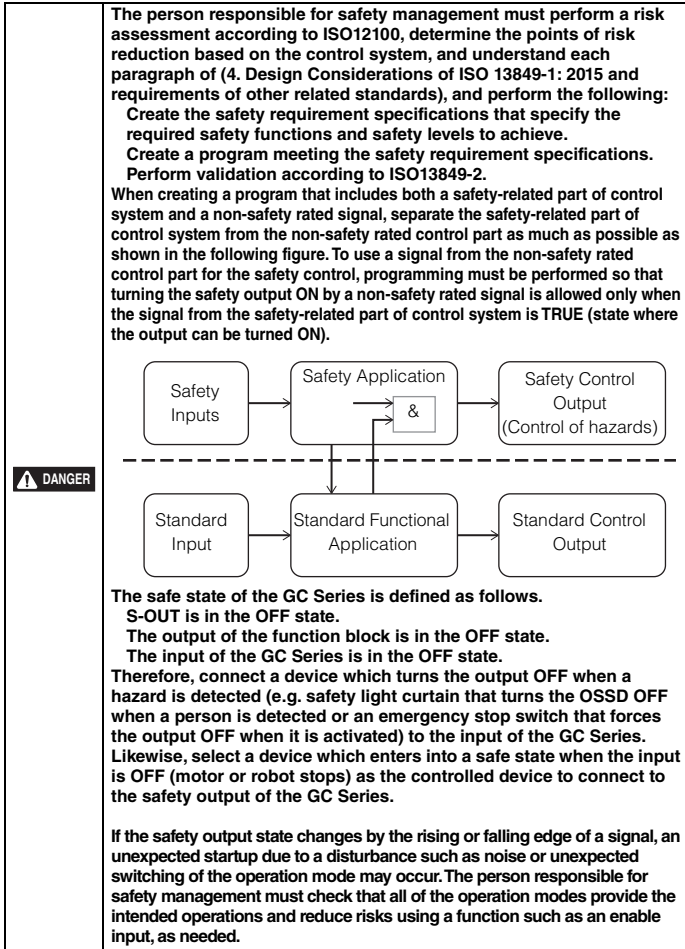

## ■ Precautions for using input block (input device)

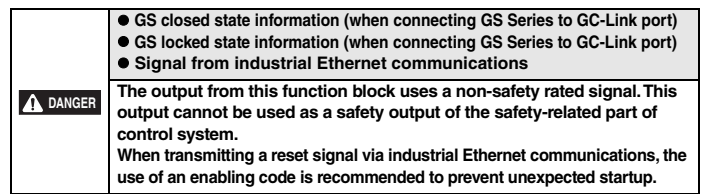
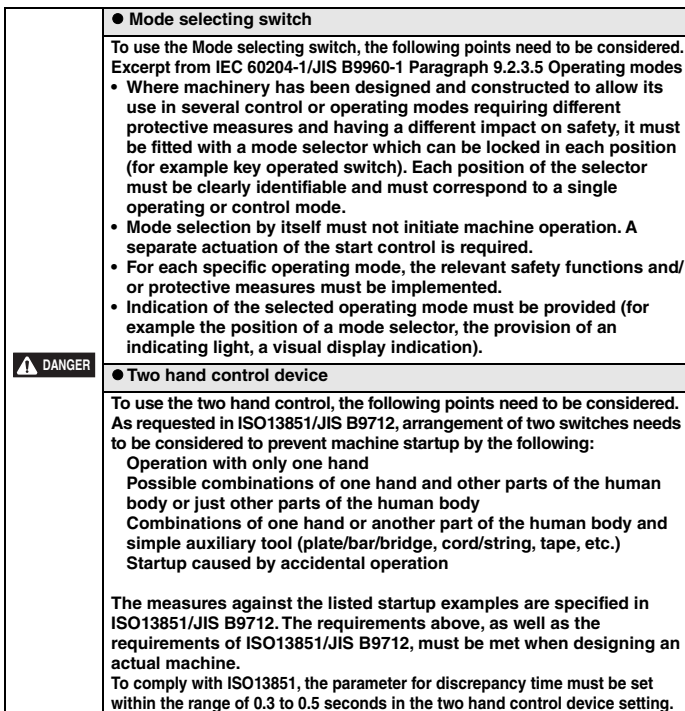

## ■ Precautions for using function block

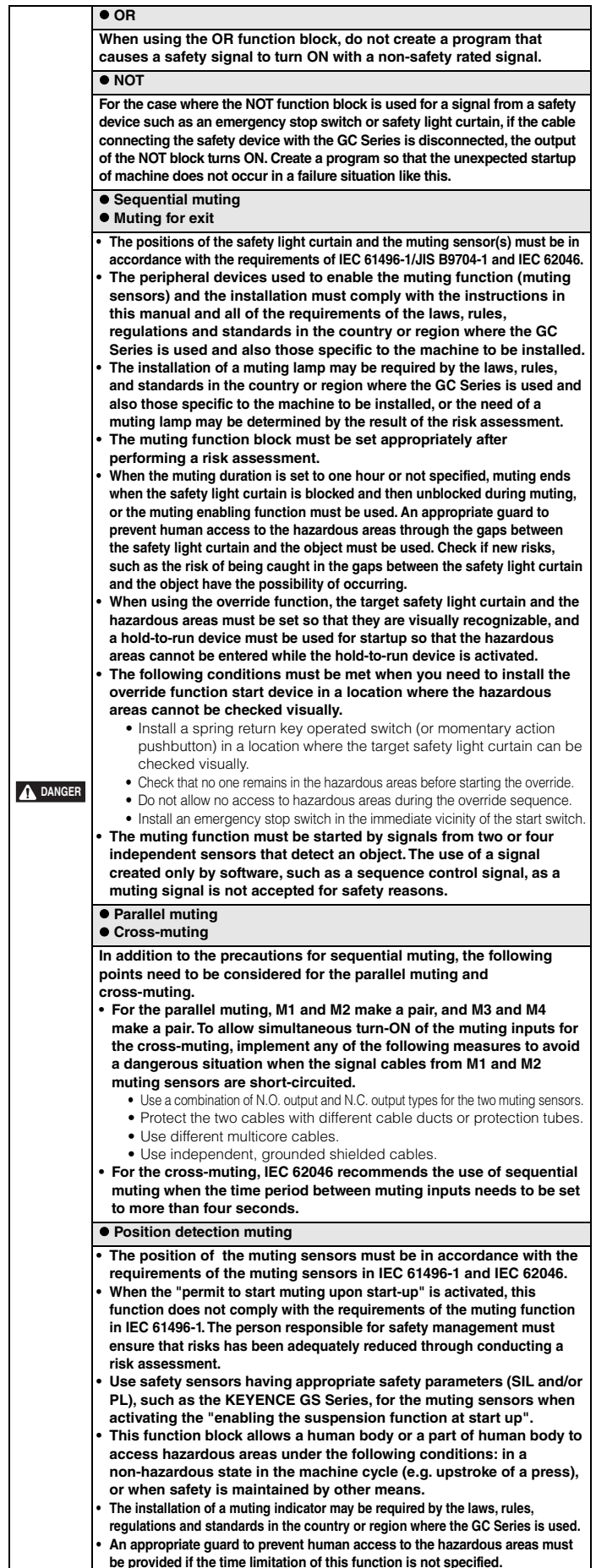

<b>⚠ DANGER</b>	<ul style="list-style-type: none"> <li>When using the override function, the target safety light curtain and hazardous areas must be set so that they are visually recognizable, and a hold-to-run device must be used for startup so that the hazardous areas cannot be entered while the switch is pressed.</li> <li>The following conditions must be met when you need to install the override function start switch in a location from which the hazardous areas cannot be checked visually. <ul style="list-style-type: none"> <li>Install a spring return key operated switch (or momentary action pushbutton) in a location from which the target safety light curtain can be checked visually.</li> <li>Check that no one remains in the hazardous areas before starting the override.</li> <li>Do not allow access to the hazardous areas during the override sequence.</li> <li>Install an emergency stop switch in the immediate vicinity of the start switch.</li> </ul> </li> <li>For muting sensors, the muting function must be started by signals from two independent sensors that detect a non-hazardous state in the machine cycle. The use of a signal created only by software, such as a sequence control signal, as a muting signal is not accepted for safety reasons.</li> <li>Follow any of the following measures for signal cables from muting sensors. <ul style="list-style-type: none"> <li>Use a combination of N.O. output and N.C. output types for the two sensors.</li> <li>Protect the two cables with different cable ducts or protection tubes.</li> <li>Use different multicore cables.</li> <li>Use independent, grounded shielded cables.</li> <li>Use safety sensors like the KEYENCE GS Series.</li> </ul> </li> </ul>																								
	<ul style="list-style-type: none"> <li><b>Reset</b> <ul style="list-style-type: none"> <li>Reset (with AND)</li> <li>Master ON</li> </ul> </li> </ul>																								
	<ul style="list-style-type: none"> <li>Use this function block in accordance with paragraph 5.2.2 of ISO13849-1: 2015.</li> <li>In the case where the input cable from the reset switch is short-circuited with +24 V power or another signal cable, unexpected reset clearing may occur. If there is such a risk, include one or more of the following measures for protection. <ul style="list-style-type: none"> <li>Introduce an appropriate measure to protect the cable from short-circuit with other signal cables.</li> <li>Use the test output and activate the monitoring function to detect a short-circuit failure.</li> <li>Select the pulse input in the reset input setting.</li> </ul> </li> <li>When an edge input is selected for the reset input setting, this function does not comply with the requirements of paragraph 5.2.2 of ISO13849-1: 2015. Unexpected reset clearing may occur due to noise and other such momentary pulse signals. Therefore, it is recommended to use the pulse input setting except in cases where not doing so is permissible from the results of the risk assessment. If the use of an edge input is unavoidable, it is recommended to use the reset enable input function to avoid the previously mentioned risks.</li> <li>The reset input of this function block must be performed from a manually operated device.</li> <li>The manually operated device for reset clearing (actuator or switch) must be situated outside the hazardous areas and in a position where the operator is able to check that no one is within the hazardous area.</li> <li>The installation of an interlock state indicator may be required by the laws, rules, regulations and standards in the country or region where the GC Series is used.</li> </ul>																								
	<ul style="list-style-type: none"> <li><b>Dual reset</b></li> </ul>																								
	<p>In addition to the precautions for reset function block, the following points need to be considered for the dual reset.</p> <ul style="list-style-type: none"> <li>The manually operated device for reset 2 (actuator or switch) must be situated outside of the hazardous areas.</li> <li>An operator who exits from the hazardous area last must operate the manually operated device for reset 1 (actuator or switch).</li> <li>It is recommended that the manually operated device for reset 2 (actuator or switch) be installed in a position where the operator is able to check that no one is within the hazardous area if it is possible that more than one operator may enter the hazardous areas.</li> <li>This function block should not be used in applications where a person may enter a hazardous area before the operator operates the reset 2 manually operated device after operating reset 1.</li> </ul>																								
	<ul style="list-style-type: none"> <li><b>Existence detection reset</b></li> </ul>																								
	<p>In addition to the precautions for reset function block, the following points need to be considered for the existence detection reset.</p> <ul style="list-style-type: none"> <li>For the reset enable signal, apply a signal from a presence sensing device such as safety laser scanner or safety light curtain.</li> </ul>																								
	<ul style="list-style-type: none"> <li><b>Mode changing control</b></li> </ul>																								
	<p>In addition to the precautions for the mode selecting switch, the following points need to be considered for the mode changing control. Unintentional mode change might occur due to the disconnection of a cable from an input device, depending on the setting of this function block. Unintentional mode change can be prevented by setting Mode 4. This mode, which is not commonly used (as shown below), can be used to prevent unintentional mode changes that may occur through disconnected cables.</p>																								
	<table border="1"> <thead> <tr> <th></th> <th>IN 1</th> <th>IN 2</th> <th>IN 3</th> <th>Note</th> </tr> </thead> <tbody> <tr> <td>Mode Output 1</td> <td style="text-align: center;">✓</td> <td></td> <td></td> <td>Output when mode 1 is selected</td> </tr> <tr> <td>Mode Output 2</td> <td></td> <td style="text-align: center;">✓</td> <td></td> <td>Output when mode 2 is selected</td> </tr> <tr> <td>Mode Output 3</td> <td></td> <td></td> <td style="text-align: center;">✓</td> <td>Output when mode 3 is selected</td> </tr> <tr> <td>Mode Output 4</td> <td></td> <td></td> <td></td> <td>When this mode is selected and a program causing all the safety outputs of the GC Series to turn OFF is used, unintentional mode change at cable disconnection, etc. can be prevented.</td> </tr> </tbody> </table>		IN 1	IN 2	IN 3	Note	Mode Output 1	✓			Output when mode 1 is selected	Mode Output 2		✓		Output when mode 2 is selected	Mode Output 3			✓	Output when mode 3 is selected	Mode Output 4			
	IN 1	IN 2	IN 3	Note																					
Mode Output 1	✓			Output when mode 1 is selected																					
Mode Output 2		✓		Output when mode 2 is selected																					
Mode Output 3			✓	Output when mode 3 is selected																					
Mode Output 4				When this mode is selected and a program causing all the safety outputs of the GC Series to turn OFF is used, unintentional mode change at cable disconnection, etc. can be prevented.																					

<b>⚠ DANGER</b>	<ul style="list-style-type: none"> <li><b>Manual mode control (MMC)</b></li> </ul>
	<ul style="list-style-type: none"> <li>The person responsible for safety management must confirm the compliance with the requirements of Suspension of safety functions and/or protective measures specified in IEC 60204-1 and also the requirements of Operational modes specified in ISO 10218-1 for robot application using an actual program.</li> <li>Unexpected startup of the machine may occur in mode switching from the manual to auto mode when using the setting that does not use a restart input. If it is impermissible in the risk assessment of the machine, include another measure to prevent unexpected startup.</li> <li>Setting a suspension of the safety function for an emergency stop device is prohibited. The person responsible for safety management must confirm that all of the emergency stop devices can operate, even if in the manual mode. Create a program so that a hazard is not started by the operation other than that of a hold-to-run device in the manual mode. Startup of the machine in the manual mode is permitted through the operation of a hold-to-run device or similar device. A three-position enabling switch, momentary switch, two hand control or an equivalent can be used as a hold-to-run device.</li> <li>It is strongly recommended to avoid using more than one manual mode control for one machine. If more than one manual mode control needs to be used for an unavoidable reason, create a program so that an unexpected startup is not caused by another manual mode control while in the manual mode.</li> <li>To prevent unintended suspension of safety device, it is recommended to use a mode selector switch with a key for selecting the manual mode.</li> <li>Install an emergency stop switch where the operator can easily reach it in the case where the operator may come close to a hazard in the manual mode.</li> <li>The installation of a manual mode state indicator may be required by the laws, rules, regulations and standards in the country or region where the GC Series is used.</li> <li>To comply with ANSI B11.19, a display or indicator which indicates the state of suspension of a safety device is required. It must be located where the operator can recognize that he/she is near the safety device of the suspension target. Periodic inspection is required for the indicator.</li> </ul>
	<ul style="list-style-type: none"> <li><b>Unlock control</b></li> </ul>
	<ul style="list-style-type: none"> <li>The output of this function block must be used in combination with the unlock output of the guard locking switch.</li> <li>This function block can be used for both "Power-to-release" and "Power-to-lock". The selection can be made in the unlock output setting for guard locking switch.</li> <li>When using the guard locking function of guard locking switch in the safety-related part of control system, for the unlock control signal, input a signal that turns ON when no hazard exists in a protection area. The following lists the details of the state. <ul style="list-style-type: none"> <li>The speed of the movable part of the hazard drops below the speed with sufficiently low risk.</li> <li>The torque of the movable part of the hazard becomes the torque with sufficiently low risk.</li> <li>The drive source of the hazard turns OFF.</li> </ul> </li> <li>ON delay for unlock enable input must be specified in consideration of machine-to-machine variations and deterioration of the machine.</li> </ul>
	<ul style="list-style-type: none"> <li><b>Bypass</b></li> </ul>
	<ul style="list-style-type: none"> <li>To cause a suspension of a safety function using this function block, programming must be performed in compliance with the relevant standards such as Suspension of safety functions and/or protective measures specified in IEC 60204-1 and Operational modes specified in ISO 10218-1. The person responsible for safety management must ensure that the requirements of applicable standards are met and risks has been reduced sufficiently through conducting a risk assessment.</li> <li>It is strongly recommended to use Manual mode control function block to comply with the requirements of applicable standards. There is no option to fulfill the requirements with Bypass function block only.</li> <li>Connect a signal from a device having appropriate safety parameters based on SIL, PLr, etc. required in the risk assessment to the bypass signal of this function block. Note that when performing bypassing with a signal other than the appropriate safety signal, the safety level of entire machine is decreased to the safety level held by this signal.</li> <li>Be sure that the duration time for bypassing is the minimum amount of time required for the application. When the duration time needs to be set to one hour or more, use the bypass enabling function or a signal from a safety device.</li> <li>To allow bypassing at startup, input a signal from a safety device having the appropriate safety level for the bypass signal.</li> <li>This function block is not for muting function. Use muting function block for the muting function.</li> </ul>
	<ul style="list-style-type: none"> <li><b>Control guard</b></li> </ul>
	<p>To use this function, the following requirements related to ISO12100 for an interlocking guard with a start function (control guards) must be met.</p> <ul style="list-style-type: none"> <li>The requirements of ISO14119 for the interlocking guard must be met.</li> <li>The cycle time of the machine is short.</li> <li>The auto start tolerance time must be set as short as possible (e.g. not greater than the cycle time).</li> <li>While the guard is closed, a human body or a part of a human body must not be allowed to enter the area between the guard and hazardous area.</li> <li>Guards that can access the same hazard (fixed (removable type) or movable guard) must be interlocking guards equipped with an interlock switch or the equivalent.</li> <li>The guard must be securely held open using a spring or counterweight such that it cannot initiate a startup when it is closed unintentionally.</li> <li>The interlock switch used to detect opening/closing of the guard must satisfy the appropriate safety level (SIL, PLr) according to the risk assessment result.</li> </ul>



<b>⚠ DANGER</b>	<ul style="list-style-type: none"> <li>● <b>PSDI</b></li> <li>● IEC 61496-1 Type 4 safety light curtain must be used.</li> <li>● Safety light curtain with appropriate detection capability must be used. <ul style="list-style-type: none"> <li>• No greater than 30 mm for hand detection or 50 mm for leg/whole body detection (IEC 62046)</li> <li>• No greater than 32 mm (ANSI B11.19)</li> </ul> </li> <li>● Use this function only with machines which can be stopped immediately anywhere in their cycle.</li> <li>● Install the safety light curtain with an appropriate safety distance maintained from a hazard.</li> <li>● A hazard must not be accessed by a route outside the area protected by the safety light curtain.</li> <li>● Guards that protect a hazard (fixed (removable type) or movable guard) must be an interlocking guards equipped with interlock switch or the equivalent.</li> <li>● Use a signal with an appropriate safety level for the top dead center, bottom dead center, upstroke signal, etc.</li> <li>● The GC Series has not been verified as a device specified in Chapter 4-2 Presence Sensing Device Initiation in Announcement No. 5 Safety device standards for press machines and shearing machines issued by the Ministry of Health, Labour and Welfare of Japan on January 12, 2011. Therefore, the PSDI function cannot be used on a power press machine in Japan.</li> <li>● When using "disable light curtain during upstroke" function, perform enough risk assessment and use additional safeguard measures upon requirement.</li> </ul>
	<ul style="list-style-type: none"> <li>● Edge detection</li> </ul>
	<ul style="list-style-type: none"> <li>● Create a program so that an unexpected startup is not caused by noise or other such momentary pulse signals.</li> </ul>

### ■ Precautions for using output block (output device)

<b>⚠ DANGER</b>	<ul style="list-style-type: none"> <li>● <b>S-OUT safety output x 1</b></li> <li>● It is possible to select single output and achieve the safety level of PLe/SIL3. To achieve a safety level of SIL3, PLe with a single safety output, apply protection to avoid short circuit between the safety output of the GC series and the power line, according to ISO 13849-2.</li> <li>● If the output self-diagnosis is disabled, the achievable safety level becomes PLd, SIL2.</li> </ul>
	<ul style="list-style-type: none"> <li>● <b>S-OUT safety output x 2</b></li> <li>● If the output self-diagnosis is disabled, the achievable safety level becomes PLd, SIL2.</li> </ul>
	<ul style="list-style-type: none"> <li>● <b>Unlock output</b></li> </ul>
	<p>The achievable safety level of the guard locking function varies by the selected output.</p> <p><b>PLe/SIL3</b></p> <ul style="list-style-type: none"> <li>● When connecting the KEYENCE GS Series power-to-release type sensor via GC-Link.</li> <li>● When connecting via a terminal block (safety output x 2) (with the output self-diagnosis enabled).</li> </ul> <p><b>PLd/SIL2</b></p> <ul style="list-style-type: none"> <li>● When connecting via a terminal block (safety output x 1) (with the output self-diagnosis enabled).</li> </ul>

### ■ Precautions for other function block

<b>⚠ DANGER</b>	<ul style="list-style-type: none"> <li>● <b>SZ-V Series bank output</b></li> <li>● When using the bank switching function, someone may be able to approach a hazardous area/hazard without passing through the protection area if bank switching is performed at an unintended timing. Therefore, the person responsible for safety management must confirm that the appropriate protection area is set/selected for the safety laser scanner in all operation modes of the machine including the bank switching time.</li> <li>● This function is available only on KEYENCE SZ-V series.</li> </ul>
	<ul style="list-style-type: none"> <li>● <b>Filter (OFF to ON)</b></li> </ul>
	<ul style="list-style-type: none"> <li>● When applying the filter (OFF to ON) settings of 0.5 ms or 1 ms to an input device, install a resistor with 2.2 kΩ or smaller resistance between 0 V and the safety input terminal this input device is assigned to.</li> </ul>

## Precautions on Regulations and Standards

### ■ CE marking

KEYENCE Corporation has confirmed that this product complies with the essential requirements of the applicable EU Directive(s), based on the following specifications. Be sure to consider the following specifications when using this product in the Member States of European Union.

- Machinery directive
  - The GC Series is a safety component defined in the EU Machinery Directive Annex V. The GC Series complies with the following EN Standards and has been certified by TÜV SÜD Product Service GmbH.
    - EN 61508 SIL 3
    - EN 62061 SIL CL3
    - EN ISO 13849-1 Category 4, PLe
    - EN 61131-2
    - EN 61131-6
    - EN 61010-1
    - EN 61010-2-201

Be sure to consider the following specifications when using this product as a product certified by TÜV SÜD.

- Use this product under pollution degree 2.
- Use this product at the altitude of 2000 m or less.
- Indoor use only
- Use a power supply with Class 2 output defined in NEC (National Electrical Code) and CEC (Canadian Electrical Code).
- The GC series (except for the remote I/O modules) is open equipment. Install the product in an enclosure rated IP 54 or better (e.g. Industrial control panel).
- Ensure the circuits to be connected to the output terminals (except for the relay outputs of the GC-1000R) are SELV circuits.
- Perform wiring of GC-1000R relay output terminal block using an electric wire of AWG#12 to 26 having temperature rating of 80 °C or higher.
- When turning on the power of the GC Series, be sure to have rated voltage reached within 30 seconds after the power supply voltage starts to rise.
- EMC directive
  - EN61131-2 Class A Zone B
  - Install the main controller or expansion unit of the GC Series in an enclosure rated IP54 or better (e.g. control panel).
  - Use the specified cable for the cable between the main controller and remote I/O module and also bus extension unit cable among the signal wires that come out of the enclosure (e.g. control panel).
  - Be sure to use a shielded cable for the Ethernet cable.
  - For the unit equipped with FE terminal, be sure to ground the FE terminal.

These specifications do not give any guarantee that the end-product with this product incorporated complies with the essential requirements of EMC Directive. The manufacturer of the end-product is solely responsible for the compliance on the end-product itself according to EMC Directives.

### ■ North American Regulations

The GC Series complies with the following North American regulations.

- FCC Part15 Subpart B, Class A Digital Device
- ICES-003, Class A Digital Apparatus

Operation is subject to the following two conditions:

(1) This device may not cause harmful interference, and (2) this device must accept any interference received, including interference that may cause undesired operation.

### FCC CAUTION

Changes or modifications not expressly approved by the party responsible for compliance could void the user's authority to operate the equipment.

### ■ UL and CSA Certificate

The GC Series complies with the following UL and CSA standards and has been certified by UL and CSA.

- UL61010-1
- UL61010-2-201
- CAN/CSA C22.2 No.61010-1
- CAN/CSA C22.2 No.61010-2-201

Additionally, the GC Series complies with the following standards and has been certified by UL.

- IEC61508 SIL3
- IEC62061 SIL3 CL3
- ISO13849-1 Category 4, PLe
- IEC61131-6
- UL1998

UL and C-UL certification:

- UL File No. E207185
- Category NRAQ, NRAQ7, FSPC, FSPC7

Be sure to consider the following specifications when using this product as a product certified by UL and CSA.

- Use this product under pollution degree 2.
- Install this product at the altitude of 2000 m or less.
- Indoor use only.
- Use a UL or CSA certified power supply with Class 2 output defined in NEC (National Electrical Code) and CEC (Canadian Electrical Code).
- Install this product in an enclosure rated IP54 or better (e.g. control panel) (remote I/O module excluded).
- Ensure that the circuits to be connected to the input/output terminals (except for the relay output terminals of GC-1000R) of this product are SELV circuits.
- Perform wiring of GC-1000R relay output terminal block using an electric wire of AWG#12 to 26 having temperature rating of 80°C or higher. The marking "⚠" beside the terminal block intends to indicate this instruction.

### ■ KC mark (Republic of Korea)

사용자 안내문

이 기기는 업무용 환경에서 사용할 목적으로 적합성평가를 받은 기기로서 가정용 환경에서 사용하는 경우 전파간섭의 우려가 있습니다.

## Package Contents

The package contains the following devices and materials: check that none of the items are missing before use. Every possible measure has been taken to ensure proper packing, however, should a defective or damaged item be found, please contact the nearest KEYENCE office.

### ■ GC-1000

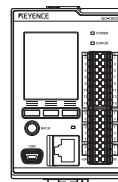

This manual  
Instruction Manual

### ■ GC-1000R

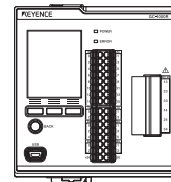

This manual  
Instruction Manual

## Installation

### ■ Precautions for installation

#### ● Installation environment

<b>⚠ DANGER</b>	<p><b>Do not install this product in the following places:</b></p> <ul style="list-style-type: none"> <li>Place exposed to direct sunlight.</li> <li>Place where the ambient temperature exceeds the range of -10 to +55 °C.</li> <li>Place where the ambient humidity exceeds the range of 5 to 85% RH.</li> <li>Place where dew condensation occurs due to rapid temperature change.</li> <li>Place where a corrosive or combustible gas is present.</li> <li>Dusty place or place with a high content of salt, iron powder or oil smoke.</li> <li>Place subjected to direct vibration or impact.</li> <li>Place exposed to spray of water, oil, chemicals, etc.</li> <li>Place generating a strong magnetic field or intense electric field.</li> <li>Place at an altitude exceeding 2000 m.</li> <li>Place with a risk of radiation exposure.</li> </ul>

#### ● Installation method

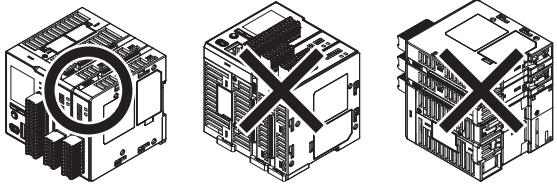
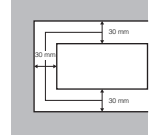
<b>⚠ DANGER</b>	<ul style="list-style-type: none"> <li>Install this product in a control panel, etc. which has the enclosure rating of IP54 or better.</li> <li>Use a 35-mm-wide DIN rail for the installation. Hook the upper groove of the DIN rail on the DIN rail mounting tab on the rear side and fit the bottom side of the DIN rail into the lower DIN rail mounting tab of each unit. Check that the lower DIN rail mounting tab is pushed in.</li> <li>Be sure to perform functional grounding for the DIN rail.</li> <li>When installing the GC Series inside a panel, be sure to make the front panel and input/output connectors face forward.</li> </ul>
	<div style="display: flex; justify-content: space-around; align-items: center;">  </div> <ul style="list-style-type: none"> <li>Be sure to keep a clearance of at least 30 mm from the surrounding wall or device when installing.</li> </ul> <div style="display: flex; align-items: center; margin-top: 10px;">  <div style="margin-left: 10px;"> <p>Top, left, bottom keep a clearance of at least 30 mm</p> </div> </div> <ul style="list-style-type: none"> <li>If the temperature inside the panel (temperature at the bottom of the unit) exceeds the ambient temperature for use, introduce a measure, such as using forced air cooling or increasing the clearance from the surroundings for better ventilation, to decrease the temperature. When using a bus extension unit, separate the upper unit from the lower unit by at least 60 mm in consideration of the influence of heat.</li> </ul>

#### ● Expansion unit connection

When installing an expansion unit, remove the expansion unit connector cover on the right side and insert the lock lever of the right unit into the lock lever slot of the left unit. Then lock the upper and lower lock levers of the right unit.

<b>⚠ Point</b>	<ul style="list-style-type: none"> <li>Installation of expansion units or remote I/O modules is prohibited when using the GC-1000R (built-in relay type).</li> </ul>
	<ul style="list-style-type: none"> <li>Only GC-S1R or GC-B30 can be connected to the right side of GC-S1R unit.</li> </ul>

#### ● Maximum number of units to be connected and cable length

When using the GC-1000, up to ten expansion units and four remote I/O modules can be connected to a single main controller (bus extension unit excluded). When a bus extension unit is used, an expansion unit can be installed to a control panel in a remote location. A maximum of ten expansion units can be connected to a single main controller when using a bus extension unit.

Refer to the "Safety Controller GC Series Expansion Unit Instruction Manual" for details of the expansion unit and the "Safety Controller GC Series Remote I/O Module Instruction Manual" for details of the remote I/O module.

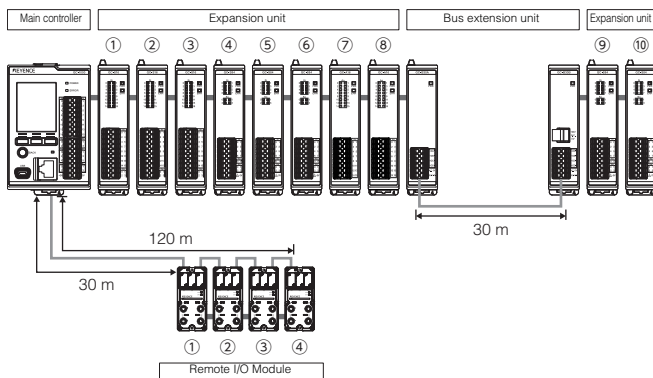

## Specifications

Model		GC-1000	GC-1000R
Input/output point	Safety input	16	14
	Safety output	6	4
	Safety relay output	--	1 (3a)
	AUX output	4	4
	Test outputs	4	4
Maximum number of expansion units to be connected		10 <sup>*1</sup>	--
Maximum number of connected remote I/O modules		4	--
GC-Link port		2 ports	2 ports
Communication interface	USB	USB2.0	
	Ethernet	100BASE-TX STP (shielded twisted pair) cable of Category 5 or higher	--
Network function		EtherNet/IP, PROFINET, Modbus/TCP, MC protocol, UDP	--
Use environment	Ambient temperature for use	-10 to +55 °C (no freezing)	
	Ambient humidity for use	5 to 85% (no condensation)	
	Storage temperature	-25 to +70°C (no freezing)	
	Vibration resistance	Frequency: 5 to 9 Hz, Half amplitude: 3.5 mm Frequency: 9 to 150 Hz, Acceleration: 10 m/s <sup>2</sup> 10 times each in X, Y, Z directions	
	Shock resistance	Acceleration: 150 m/s <sup>2</sup> , Operating time: 11 ms, 3 times each in X, Y, Z directions	
	Overvoltage category	II	
	Pollution degree	2	
	Altitude for use	Max. 2000 m	
Applicable standard	EMC	EMS: IEC 61131-2/-6, EN61131-2/-6 EMI: IEC 61131-2, FCC Part15B Class A, ICES-003 Class A	
	Safety	IEC 61508, EN61508 SIL3 IEC 62061, EN62061 SIL CL3 ISO/EN13849-1:2015 Cat. 4, PL e, UL1998	
Power supply	Power voltage	24 VDC (-30 to +20%) <sup>2</sup> Class 2	24 VDC (-20 to +20%) Class 2
	Consumption current	Max. 200 mA	
Dimension (W x D x H)		60 x 95 x 90	85 x 95 x 90
Material		Polycarbonate	
Weight		Approx. 260 g	Approx. 360 g

\*1 Bus extension unit not included in the number of units. Also, only one GC-B30 unit set can be used per main controller.

\*2 When using GC-S1R, GC-A16, GC-B30, GC-R45 or GC-R48, it is "-20 to +20%".

### ■ Safety related parameter

Following are the maximum safety parameters available.

Model		GC-1000	GC-1000R
T1 (proof test interval)		20 years	
Hardware fault tolerance		1	
Type of element		B	
Safe state		S-OUT OFF state	
SIL/SIL CL	S-OUT without self-diagnosis	2	
	Other safety outputs	3	
PFHd	S-OUT × 2 with self-diagnosis	1.02×10 <sup>-9</sup>	1.01×10 <sup>-9</sup>
	S-OUT × 1 with self-diagnosis	4.02×10 <sup>-9</sup>	4.01×10 <sup>-9</sup>
	S-OUT × 2 without self-diagnosis	1.72×10 <sup>-9</sup>	1.71×10 <sup>-9</sup>
	S-OUT × 1 without self-diagnosis	2.25×10 <sup>-9</sup>	2.24×10 <sup>-9</sup>
	S-OUT (Relay output)	--	1.27×10 <sup>-9</sup> <sup>*1</sup>
PL	S-OUT without self-diagnosis	Cat.3 PLd	
	Other safety outputs	Cat.4 PLe	

\*1 Assumes low load, nop = 8,760 per year.

### ● GS series connected by GC-Link

Model	Interlocking function	Guard locking function (GS-51Px)
PL	Cat4 PLe	Cat4 PLe
PFHd <sup>*1</sup>	4.78×10 <sup>-10</sup>	1.74×10 <sup>-10</sup>

\*1 When cascading multiple units, add up PFHd of the cascaded units.

### ■ Response time

Response time of GC series is calculated by the total of the following parameters.

Base response time		4.8 ms	
		Input ON -> OFF	Input OFF -> ON
Added time of input	Added time of input device connection destination	Main controller (GC-Link <sup>1</sup> , terminal block)	+0 ms
		Expansion unit and remote I/O module	+1.7 ms
	Added time of input block	Filtering time settings	[0.5 ms] +0.7 ms +1.2 ms Min. [1 ms] + Filtering time + Filtering time + 0.5 ms
	Use test output	+4.5 ms	+34 ms

		Output ON -> OFF	Output OFF -> ON
Added time of output	Added time of output device connection destination	Main controller	+0 ms
		Expansion unit and remote I/O module	+2.4 ms
	Added time of output block <sup>*2</sup>	S-OUT (semiconductor output)	+0 ms
		S-OUT (relay output)	+10 ms

\*1 When using GC-Link connection, add the response time of the sensor used.

\*2 For AUX output, add 0.5 ms.

\*3 The minimum OFF time of relay output is 300 ms.

When using the following functions in the program, please add the time consumed by the function.

- When using OFF-delay or ON-delay function, add delay time.
- When using multiple registers in series, add +2 ms for each pair of register (store) and register (load).  
For example, if 2 register pairs are used in series, please add +4 ms.

### ■ Safety input specification

Item	Specification
Input device	Contact output device or PNP output device
Input type	Type3
ON level (voltage/current)	Min. 11 V/2 mA
OFF level (voltage/current)	Max. 5 V/1.5 mA
Short-circuit current	Si 0 to 3: Approx. 5 mA
	Si 4 to 15: Approx. 3 mA*
Protection circuit	Surge protection circuit, wrong wiring protection circuit
Maximum cable length	Max. 100 m

\* Si 4 to 13 for GC-1000R

### ■ Safety output specifications (semiconductor output)

Item	Specification
Output type	PNP transistor output (DC-13, Type 0.5, protected outputs)*
Maximum load current	500 mA
Residual voltage (during ON)	Max. 2.0 V
Leakage current (during OFF)	Max. 0.5 mA
Maximum capacitive load	0.5 μF
Load wiring resistance	Max. 2.5 Ω
Protection circuit	Overcurrent protection circuit, reverse connection protection circuit
Maximum cable length	Max. 30 m

\* Paragraph 6.4.6 Temporary overload of IEC 61131-2 supports up to 1.2 times the maximum load current.

### ■ Safety output specifications (relay output) \*GC-1000R only

Item	Specification
Output type	Relay (3a) (AC-15, DC-13, Type 2, Externally-protected outputs, R300, B300)* <sup>1</sup>
Rated load (resistance load)	250 VAC 6A / 30 VDC 6A <sup>*2 *3</sup>
Rated load (inductive load)	240 VAC 2A (AC-15) / 24 VDC 1A (DC-13) (TUV SUD, CSA Certified) B300, R300 (UL Certified)
Relay output mechanical life	Resistance load (250 VAC 6A/30 VDC 6A): Min. 100,000 times
	Resistance load (250 VAC 1A/30 VDC 1 A): Min. 500,000 times
	Inductive load (AC-15: 240 VAC 2 A): Min. 100,000 times (cosφ = 0.3)
	Inductive load (DC-13: 24 VDC 1 A): Min. 100,000 times (L/R = 48 ms)
Maximum cable length	Max. 100 m
B10d	With rated load: 400,000 With low load: 2,000,000

\*1 To meet the requirements of IEC 61131-2, connect 10A Fast blow fuse (IEC 60217) in series to each contact.

\*2 Check the derating characteristics described later.

\*3 Use this product with load current of max. 5 A at temperature of 40 °C or lower when using this product as a product certified by UL.

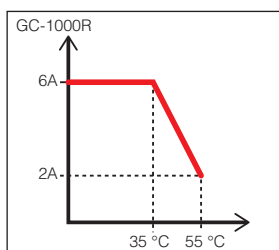

### ■ Test output specification

Item	Specification
Output type	PNP transistor output*
Maximum load current	100 mA
Protection circuit	Overcurrent protection circuit, reverse connection protection function circuit
Maximum cable length	Max. 100 m

\* Test output do not comply with paragraph 6.4.6 of IEC 61131-2.

### ■ AUX output specification

Item	Specification
Output type	Transistor output (PNP/NPN selected by wiring), PNP output (DC-13, Type 0.1, protected outputs) <sup>*1 *2</sup>
Maximum load current	PNP: 100 mA, NPN: 20 mA
Residual voltage (during ON)	Max. 2.0 V
Leakage current (during OFF)	Max. 0.5 mA
Protection circuit	Overcurrent protection circuit, reverse connection protection function circuit
Maximum cable length	Max. 30 m

\*1 Paragraph 6.4.6 Temporary overload of IEC 61131-2 supports up to 1.2 times the maximum load current.

\*2 For AUX output, only the PNP output complies with paragraph 6.4.6 of IEC 61131-2.

## Part Names

### ■ GC-1000

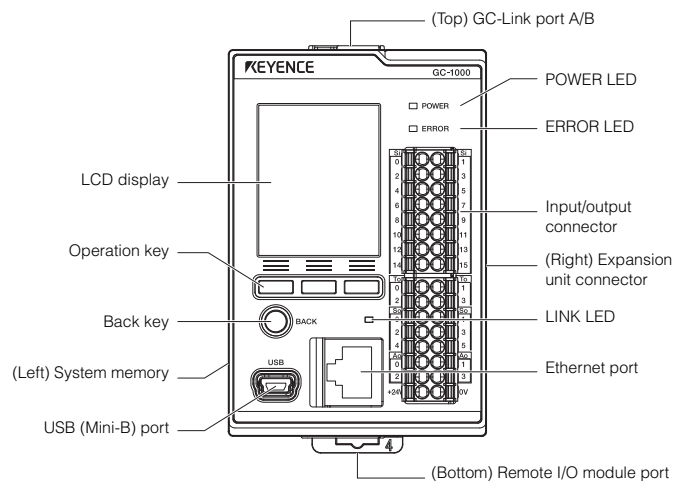

### ■ GC-1000R

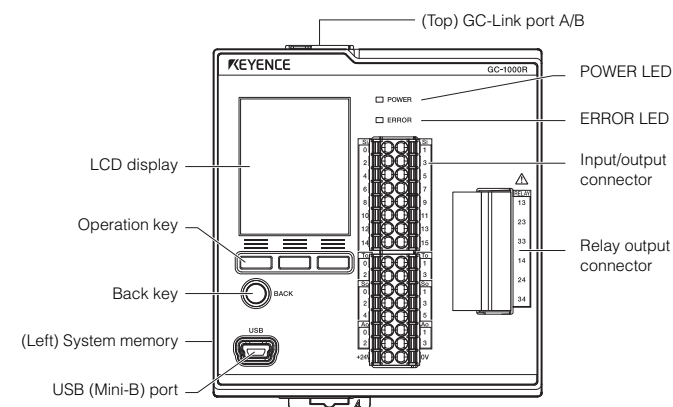

### ● Operation indicator (LED)

POWER LED	ON in green	Turns on in green while power is supplied.
	OFF	Power is not supplied.
ERROR LED	Blinks in red	Blinks in red when an error occurs.
	OFF	No error occurs.
LINK LED*	ON in green	Link established.
	Blinks in green	Data being transmitted.
	OFF	Link not established.

\* This is not available on the GC-1000R.

## Input/Output Connector Terminal Arrangement

### GC-1000

#### Input/output connector

0	Si0	Si1	1	Safety inputs Si
2	Si2	Si3	3	
4	Si4	Si5	5	
6	Si6	Si7	7	
8	Si8	Si9	9	
10	Si10	Si11	11	
12	Si12	Si13	13	Test outputs To
14	Si14	Si15	15	
0	To0	To1	1	Safety outputs So
2	To2	To3	3	
0	So0	So1	1	
2	So2	So3	3	
4	So4	So5	5	AUX outputs Ao
0	Ao0	Ao1	1	
2	Ao2	Ao3	3	
	+24V	0V		

### GC-1000R

#### Input/output connector

0	Si0	Si1	1	Safety inputs Si
2	Si2	Si3	3	
4	Si4	Si5	5	
6	Si6	Si7	7	
8	Si8	Si9	9	
10	Si10	Si11	11	
12	Si12	Si13	13	Test outputs To
14	N.C.	N.C.	15	
0	To0	To1	1	Safety outputs So
2	To2	To3	3	
0	So0	So1	1	
2	So2	So3	3	
4	N.C.	N.C.	5	AUX outputs Ao
0	Ao0	Ao1	1	
2	Ao2	Ao3	3	
	+24V	0V		

#### Relay output connector

13	SRo
23	SRo
33	SRo
14	SRo
24	SRo
34	SRo

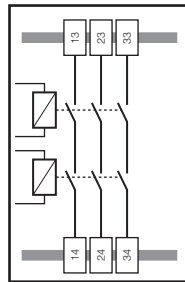

Common rail of PNP output is electrically connected to the +24V terminal inside the GC Series unit.

## Wiring

### Input/output connector terminal block specifications

Item	Details
Compatible cable size	UL AWG16 to 26 (copper wire, stranded wire) IEC 0.2 mm <sup>2</sup> to 1.5 mm <sup>2</sup>
Cable sheath stripping length	10.0 mm
Cable rated temperature	Use a cable with a rated temperature of 80 °C or higher.

### Relay output terminal block specifications

Item	Details
Compatible cable size	UL AWG12 to 26 (copper wire, stranded wire) IEC 0.2 mm <sup>2</sup> to 2.5 mm <sup>2</sup>
Cable sheath stripping length	10.0 mm
Cable rated temperature	Use a cable with a rated temperature of 80 °C or higher.

### GC-B30B power supply terminal block specifications

Item	Details
Compatible cable size	UL AWG20 to 26 (copper wire, stranded wire) IEC 0.2 mm <sup>2</sup> to 0.5 mm <sup>2</sup>
Cable sheath stripping length	8.0 mm
Cable rated temperature	Use a cable with a rated temperature of 80 °C or higher.

### Example of connection with an input device

2 NC contact device connection  
example using the test output

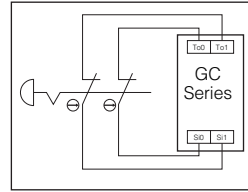

Type 4 safety light curtain  
connection example

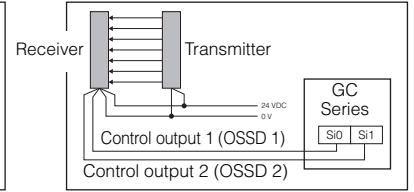

### Example of connection with output device

Safety output (Semiconductor output)

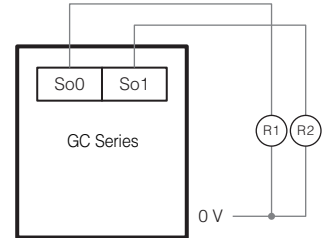

R1, R2: External device

Safety output (Relay output)

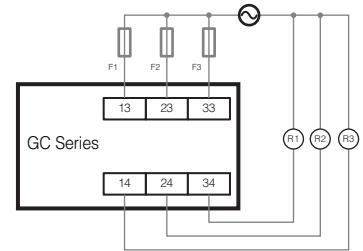

R1, R2, R3: External device  
F1, F2, F3: Fuse (10A Fast blow fuse)

## Troubleshooting

When something irregular happens to GC series, it can be categorized into following four types.

Main unit display	Contents	Program behavior
Info	Mild abnormality.	Program continues
Alert	Detected abnormal state which may affect normal operation of GC series.	Program continues
Error	Detected abnormal state which prevents from continuing normal operation. Related output block(s) will turn off.	Program continues
	Detected abnormal state in GC series itself which prevents from continuing normal operation. All output block(s) will turn off.	Program stops

## Inspection and Maintenance

Perform an inspection for the following items at the appropriate timing.

### Initial inspection

- Check that the GC Series is installed according to the installation conditions, installation methods, and wiring specifications specified in this manual.
- Periodic inspection items

### Periodic inspection

Determine the cycle based on the interval specified by local laws/rules and individual standards, and the risk assessment of the target machine. If not specified in above laws/rules/individual standards, we recommend that a periodic inspection be performed at least once a year.

- Check that all of the safety functions work correctly.
- Check that there are no changes to the status that will affect the results of the risk assessment carried out at the start of the installation.
- When the S-OUT self-diagnosis is disabled, operate the emergency stop switch, etc. to turn the target S-OUT OFF and then check that the device connected to S-OUT is stopped.

Especially in the following cases, check the same details as the initial inspection.

- When a change has been made to the installation, wiring, or functions
- When the unit has been replaced
- When the equipment is not used for a long period of time
- When a defect occurs



When the inspection of the device connected to the GC Series is required, it should be performed in addition to the initial and periodic inspections.  
Store the inspection results together with the machine's records.

To replace a damaged unit, follow the procedure below.

- Turn OFF the power supplies to the GC Series and peripheral devices including the relay output. Remove the connection cable and expansion units on both sides from the damaged unit and then remove from the DIN rail.
- When replacing the GC-1000 or the GC-1000R, remove the system memory from the system memory mounting slot on the left side and attach it to a new unit. (This is not necessary when replacing an expansion unit or remote I/O module.)
- Install the new unit to the place where the previous unit was installed, connect the new unit to the expansion units and then perform wiring as before. When connecting expansion units, make sure the order of expansion units is not changed.
- When the GC Series power is turned ON, an activation CRC error is displayed on the LCD of main controller. Clear the activation CRC error by following the on-screen instruction and then turn ON the power again.

<b>DANGER</b>	<ul style="list-style-type: none"> <li>• To prevent danger due to the machine starting, thoroughly ensure that no one is present in the hazardous zone during inspection.</li> <li>• If some error is found on the GC series as a result of the inspection, do not operate the machine.</li> </ul>
---------------	--

## Cleaning

- If there is dirt, wipe it off with a clean dry cloth.
- Use a cotton swab to remove dust and dirt attached to small parts such as connectors.

## Reference Manual

The following shows the manuals related to the safety controller of the GC Series. Read these manuals as well.

Name	Contents
Safety Controller GC Series User's Manual	Describes the system configuration, specifications, steps to startup, the GC Configurator operation method, etc. for the GC Series.
Safety Controller GC Series Function Block Reference Manual	Describes the function blocks which can be used with a safety program.

## Dimensions

### GC-1000

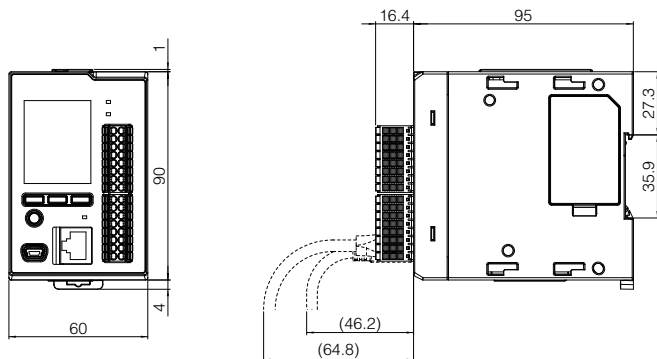

### GC-1000R

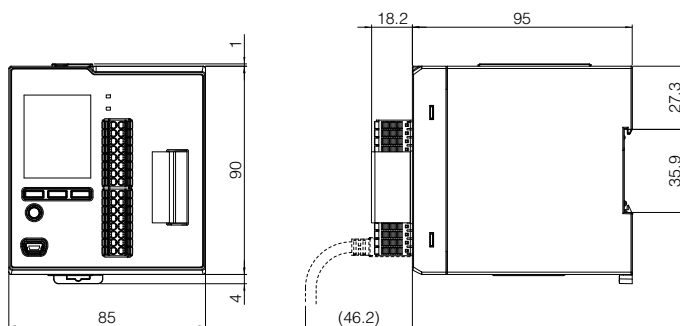

## WARRANTIES AND DISCLAIMERS

- (1) KEYENCE warrants the Products to be free of defects in materials and workmanship for a period of one (1) year from the date of shipment. If any models or samples were shown to Buyer, such models or samples were used merely to illustrate the general type and quality of the Products and not to represent that the Products would necessarily conform to said models or samples. Any Products found to be defective must be shipped to KEYENCE with all shipping costs paid by Buyer or offered to KEYENCE for inspection and examination. Upon examination by KEYENCE, KEYENCE, at its sole option, will refund the purchase price of, or repair or replace at no charge any Products found to be defective. This warranty does not apply to any defects resulting from any action of Buyer, including but not limited to improper installation, improper interfacing, improper repair, unauthorized modification, misapplication and mishandling, such as exposure to excessive current, heat, coldness, moisture, vibration or outdoors air. Components which wear are not warranted.
- (2) KEYENCE is pleased to offer suggestions on the use of its various Products. They are only suggestions, and it is Buyer's responsibility to ascertain the fitness of the Products for Buyer's intended use. KEYENCE will not be responsible for any damages that may result from the use of the Products.
- (3) The Products and any samples ("Products/Samples") supplied to Buyer are not to be used internally in humans, for human transportation, as safety devices or fail-safe systems, unless their written specifications state otherwise. Should any Products/Samples be used in such a manner or misused in any way, KEYENCE assumes no responsibility, and additionally Buyer will indemnify KEYENCE and hold KEYENCE harmless from any liability or damage whatsoever arising out of any misuse of the Products/Samples.
- (4) **OTHER THAN AS STATED HEREIN, THE PRODUCTS/SAMPLES ARE PROVIDED WITH NO OTHER WARRANTIES WHATSOEVER. ALL EXPRESS, IMPLIED, AND STATUTORY WARRANTIES, INCLUDING, WITHOUT LIMITATION, THE WARRANTIES OF MERCHANTABILITY, FITNESS FOR A PARTICULAR PURPOSE, AND NON-INFRINGEMENT OF PROPRIETARY RIGHTS, ARE EXPRESSLY DISCLAIMED. IN NO EVENT SHALL KEYENCE AND ITS AFFILIATED ENTITIES BE LIABLE TO ANY PERSON OR ENTITY FOR ANY DIRECT, INDIRECT, INCIDENTAL, PUNITIVE, SPECIAL OR CONSEQUENTIAL DAMAGES (INCLUDING, WITHOUT LIMITATION, ANY DAMAGES RESULTING FROM LOSS OF USE, BUSINESS INTERRUPTION, LOSS OF INFORMATION, LOSS OR INACCURACY OF DATA, LOSS OF PROFITS, LOSS OF SAVINGS, THE COST OF PROCUREMENT OF SUBSTITUTED GOODS, SERVICES OR TECHNOLOGIES, OR FOR ANY MATTER ARISING OUT OF OR IN CONNECTION WITH THE USE OR INABILITY TO USE THE PRODUCTS, EVEN IF KEYENCE OR ONE OF ITS AFFILIATED ENTITIES WAS ADVISED OF A POSSIBLE THIRD PARTY'S CLAIM FOR DAMAGES OR ANY OTHER CLAIM AGAINST BUYER.** In some jurisdictions, some of the foregoing warranty disclaimers or damage limitations may not apply.

### BUYER'S TRANSFER OBLIGATIONS:

If the Products/Samples purchased by Buyer are to be resold or delivered to a third party, Buyer must provide such third party with a copy of this document, all specifications, manuals, catalogs, leaflets and written information provided to Buyer pertaining to the Products/Samples.

E 1101-3

Document Control Number: 1404AAE102-04

## KEYENCE CORPORATION

1-3-14, Higashi-Nakajima, Higashi-Yodogawa-ku,  
Osaka, 533-8555, Japan  
PHONE: +81-6-6379-2211

[www.keyence.com/glb](http://www.keyence.com/glb)

<b>AUSTRIA</b> Ph: +43 2236 378266 0	<b>HONG KONG</b> Ph: +852-3104-1010	<b>NETHERLANDS</b> Ph: +31 40 20 66 100	<b>TAIWAN</b> Ph: +886-2-2721-8080
<b>BELGIUM</b> Ph: +32 15 281 222	<b>HUNGARY</b> Ph: +36 1 802 7360	<b>PHILIPPINES</b> Ph: +63-2-8981-5000	<b>THAILAND</b> Ph: +66-2-369-2777
<b>BRAZIL</b> Ph: +55-11-3045-4011	<b>INDIA</b> Ph: +91-44-4963-0900	<b>POLAND</b> Ph: +48 71 36861 60	<b>UK &amp; IRELAND</b> Ph: +44 1908-696-900
<b>CANADA</b> Ph: +1-905-366-7655	<b>INDONESIA</b> Ph: +62-21-2966-0120	<b>ROMANIA</b> Ph: +40 269 232 808	<b>USA</b> Ph: +1-201-930-0100
<b>CHINA</b> Ph: +86-21-3357-1001	<b>ITALY</b> Ph: +39-02-6688220	<b>SINGAPORE</b> Ph: +65-6392-1011	<b>VIETNAM</b> Ph: +84-24-3772-5555
<b>CZECH REPUBLIC</b> Ph: +420 220 184 700	<b>KOREA</b> Ph: +82-31-789-4300	<b>SLOVAKIA</b> Ph: +421 2 5939 6461	
<b>FRANCE</b> Ph: +33-1-56-37-78-00	<b>MALAYSIA</b> Ph: +60-3-7883-2211	<b>SLOVENIA</b> Ph: +386 1 4701 666	
<b>GERMANY</b> Ph: +49-6102-3689-0	<b>MEXICO</b> Ph: +52-55-8850-0100	<b>SWITZERLAND</b> Ph: +41 43 455 77 30	

Specifications are subject to change without notice.

A6WW1-MAN-2010

Copyright (c) 2020 KEYENCE CORPORATION. All rights reserved.  
16567GB 2070-1 [96M16567] Printed in Japan

